

ID240D01

2MB Flash Memory Card

(Model No.: ID240D01)

Spec No.: EL104047

Issue Date: May 27, 1998

- Handle this document carefully for it contains material protected by international copyright law. Any reproduction, full or in part, of this material is prohibited without the express written permission of the company.

- When using the products covered herein, please observe the conditions written herein and the precautions outlined in the following paragraphs. In no event shall the company be liable for any damages resulting from failure to strictly adhere to these conditions and precautions.
 - (1) The products covered herein are designed and manufactured for the following application areas. When using the products covered herein for the equipment listed in Paragraph (2), even for the following application areas, be sure to observe the precautions given in Paragraph (2). Never use the products for the equipment listed in Paragraph (3).
 - Office electronics
 - Instrumentation and measuring equipment
 - Machine tools
 - Audiovisual equipment
 - Home appliances
 - Communication equipment other than for trunk lines

 - (2) Those contemplating using the products covered herein for the following equipment which demands high reliability, should first contact a sales representative of the company and then accept responsibility for incorporating into the design fail-safe operation, redundancy, and other appropriate measures for ensuring reliability and safety of the equipment and the overall system.
 - Control and safety devices for airplanes, trains, automobiles, and other transportation equipment
 - Mainframe computers
 - Traffic control systems
 - Gas leak detectors and automatic cutoff devices
 - Rescue and security equipment
 - Other safety devices and safety equipment, etc.

 - (3) Do not use the products covered herein for the following equipment which demands extremely high performance in terms of functionality, reliability, or accuracy.
 - Aerospace equipment
 - Communications equipment for trunk lines
 - Control equipment for the nuclear power industry
 - Medical equipment related to life support, etc.

 - (4) Please direct all queries and comments regarding the interpretation of the above three Paragraphs to a sales representative of the company.

- Please direct all queries regarding the products covered herein to a sales representative of the company.

Contents

1. General Descriptions	p. 2
2. Features	p. 2
3. Block Diagram	p. 3
4. Pin Connections	p. 4
5. Function Chart	p. 5
5.1 Memory Block	p. 5
5.1.1 Memory Configuration	p. 5
5.1.2 Memory Erase Unit	p. 5
5.2 Function Table	p. 6
5.3 Software Command	p. 7, 8
5.4 Status Register	p. 9
5.5 Programming Flowchart	p. 10, 11
5.6 Erase Algorithm	p. 12, 13
6. Absolute Maximum Ratings	p. 14
7. Recommended Operating Conditions	p. 14
8. Capacitance	p. 14
9. Read Operation	p. 15
9.1 DC Characteristics	p. 15
9.2 AC Characteristics	p. 15, 16, 17
10. Programming Operation	p. 17
10.1 DC Characteristics	p. 17
10.2 AC Characteristics	p. 18, 19, 20
11. Erase Operation	p. 21
11.1 DC Characteristics	p. 21
11.2 AC Characteristics	p. 21, 22, 23, 24
12. Block Erase and Data Write Characteristics	P. 25
13. Voltage Timing	p. 25
14. Attribute Memory	p. 26
14.1 Attribute Memory Read/Write Function Chart	p. 26
14.2 AC Characteristics	p. 26
14.3 Attribute Memory Read Cycle	p. 27
14.4 Attribute Memory Write Cycle	p. 28, 29
15. Specification Changes	p. 30
16. Other Precautions	p. 30
17. External Diagrams	p. 31
18. Packing Specification	p. 32
19. External Appearances	p. 33

1. General Descriptions

The SHARP ID240D01 is a 2MB Flash Memory PC Card conforms to PCMCIA Release 2.0 and is offered to customers giving aim to confirm an external shape or electrical performances of the card. Before mass production, we will create a new product name dedicated for a customer and also present a specification which implies customer's request including panel design.

2. Features

- | | | |
|------|----------------------------------------------------------------------------------------------------------------------------------------------------------------------------------------------------------------|--------------------------------------------------------------------------------------------------------------------------------------------|
| 2.1 | Type | 2MB Flash Memory Card
(Conforms to PCMCIA Rel.2.0) |
| 2.2 | Memory Capacity | |
| | Common Memory | 2M words × 8 bits or 1M words × 16 bits |
| | Attribute Memory | EEPROM Model 2k words × 8 bits read/write |
| | Note) We have another type of attribute memory as follows,
No EEPROM Model. (5 words × 8 bits read only in card's control circuit.)
Sample card name: ID240D02. Customers can choose one model from two. | |
| 2.3 | Supply Voltage | |
| | Read Cycle | $V_{CC} = 5 \pm 0.5V$, V_{PP1} , $V_{PP2} = 0 \sim 1.5V$ |
| | Read/Program/Erase Cycle | $V_{CC} = 5 \pm 0.5V$, V_{PP1} , $V_{PP2} = 12.0V \pm 0.6V$ |
| 2.4 | Erase Unit | Block
(64k bytes/byte access, 128k bytes/word access) |
| 2.5 | Program/Erase Cycles | 100,000 cycles |
| 2.6 | Interface | Parallel I/O Interface |
| 2.7 | Function Table | See Function Table in page. 6 |
| 2.8 | External Dimensions | 54 × 85.6 × 3.3 mm |
| 2.9 | Pin Connections | See Pin Connections in page. 4 |
| 2.10 | Type of Connector | Conforms to PCMCIA Re1.2.0 Card Use Connector
(Card connector: JC20-J68S-NB3 JAE or FCN-568J068-G/0 Fujitsu or ICM-C68S-TS13-5035A JST) |
| 2.11 | Average Weight | 30g |
| 2.12 | Operating Temp Range | 0 to 60°C |
| 2.13 | Storage Temp Range | -20 to 65°C |
| 2.14 | External Appearance | External appearance shall be free of any dirt, cratches and abnormalities that could adversely affect sales. |
| 2.15 | Manufacturer's Code | The manufacturer's code shall be printed on the memory card directly or on the seal which is then attached to the memory card. |
| 2.16 | Brand Name | The user's brand name will be used. |
| 2.17 | Not designed or rated radiation hardened. | |

3. Block Diagram

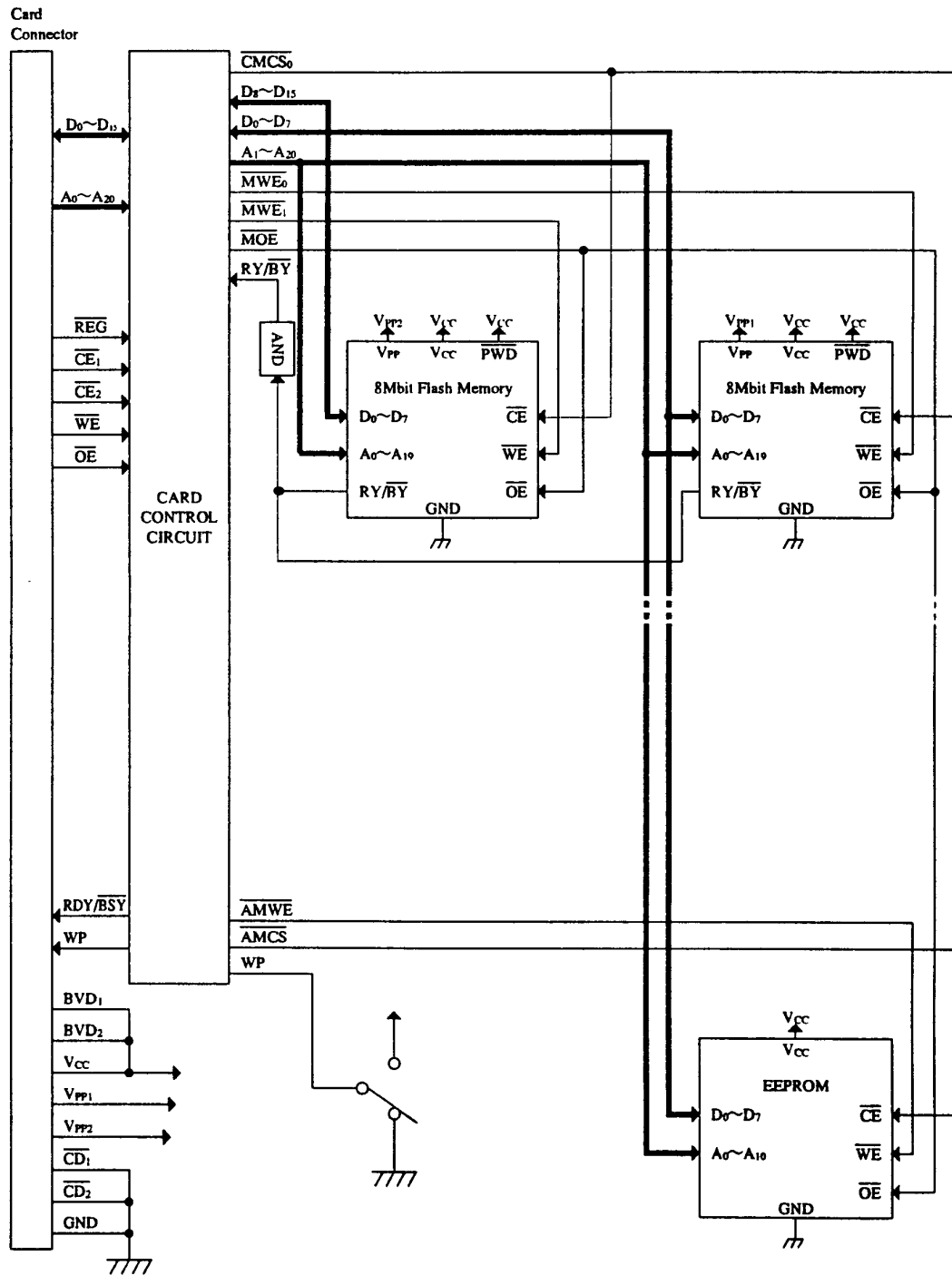

4. Pin Connections

PIN	SIGNAL	PIN	SIGNAL	PIN	SIGNAL	PIN	SIGNAL
1	GND	18	V _{PP1}	35	GND	52	V _{PP2}
2	D ₃	19	A ₁₆	36	\overline{CD}_1	53	A ₂₂ (NC)
3	D ₄	20	A ₁₅	37	D ₁₁	54	A ₂₃ (NC)
4	D ₅	21	A ₁₂	38	D ₁₂	55	A ₂₄ (NC)
5	D ₆	22	A ₇	39	D ₁₃	56	A ₂₅ (NC)
6	D ₇	23	A ₆	40	D ₁₄	57	NC
7	\overline{CE}_1	24	A ₅	41	D ₁₅	58	NC
8	A ₁₀	25	A ₄	42	\overline{CE}_2	59	NC
9	\overline{OE}	26	A ₃	43	NC	60	NC
10	A ₁₁	27	A ₂	44	NC	61	\overline{REG}
11	A ₉	28	A ₁	45	NC	62	BVD ₂
12	A ₈	29	A ₀	46	A ₁₇	63	BVD ₁
13	A ₁₃	30	D ₀	47	A ₁₈	64	D ₈
14	A ₁₄	31	D ₁	48	A ₁₉	65	D ₉
15	$\overline{WE}/\overline{PGM}$	32	D ₂	49	A ₂₀	66	D ₁₀
16	$\overline{RDY}/\overline{BSY}$	33	WP	50	A ₂₁ (NC)	67	\overline{CD}_2
17	V _{CC}	34	GND	51	V _{CC}	68	GND

Pin Descriptions :

D ₀ ~ D ₇	Data Bus (Input/output)
D ₈ ~ D ₁₅	Data Bus (Input/output)
A ₀ ~ A ₂₀	Address Bus (Input)
\overline{CE}_1 , \overline{CE}_2	Card Enable (Input)
\overline{OE}	Output Enable (Input)
$\overline{WE}/\overline{PGM}$	Write Enable/Program (Input)
\overline{CD}_1 , \overline{CD}_2	Card Detect (Output) (Card Inserted Detection Signal)
WP	Write Protect (Output) (in write protect mode, the WP output signal is "HIGH")
V _{PP1}	Program/Erase Power Supply (Even Byte)
V _{PP2}	Program/Erase Power Supply (Odd Byte)
\overline{REG}	Register Select (Input)
BVD ₁ , BVD ₂	Battery Voltage Detect (Always "HIGH")
$\overline{RDY}/\overline{BSY}$	Ready/Busy (Output)

5. Function

5.1 Memory Block

5.1.1 Memory Configuration 8Mbits Flash Memory × 2 Devices.

5.1.2 Memory Erase Unit Block Erase

Block:	Byte Mode	64k bytes
	Word Mode	128k bytes

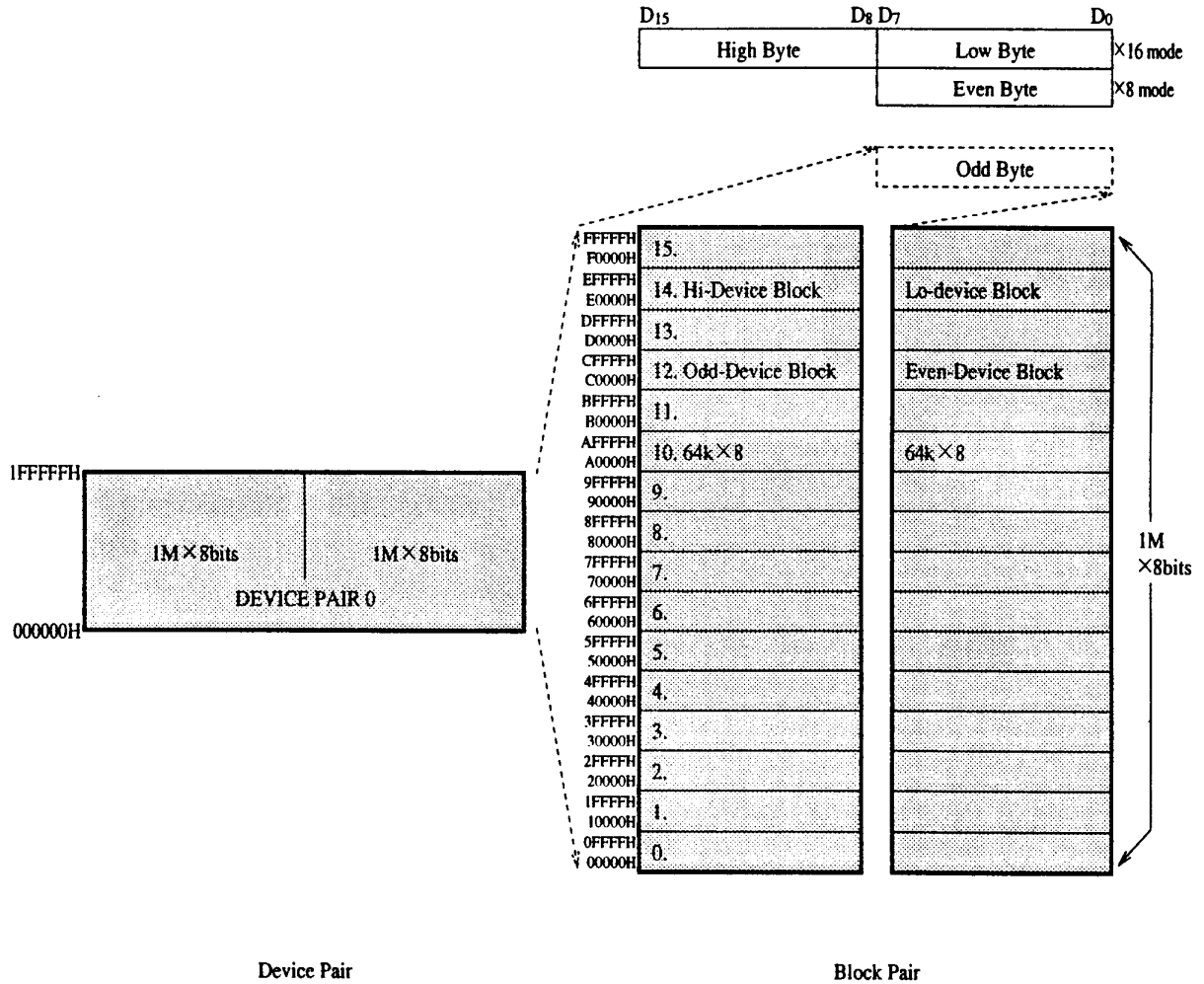

5.2 Function Table

\overline{CE}_1	\overline{CE}_2	A_0	\overline{WE}	\overline{OE}	REG	V_{PPL}	V_{PP2}	V_{CC}	Operation	D_0-D_7	D_8-D_{15}	Status
H	H	×	×	×	H	V_{PPL}	V_{PPL}	V_{CC}		Hi-Z	Hi-Z	Standby
L	H	L	H	L	H	V_{PPL}	V_{PPL}	V_{CC}	Read (×8)	Do (Even)	Hi-Z	Byte
L	H	H	H	L	H	V_{PPL}	V_{PPL}	V_{CC}	Read (×8)	Do (Odd)	Hi-Z	Byte
L	L	×	H	L	H	V_{PPL}	V_{PPL}	V_{CC}	Read (×16)	Do (Even)	Do (Odd)	Word
H	L	×	H	L	H	V_{PPL}	V_{PPL}	V_{CC}	Read (×8)	Hi-Z	Do (Odd)	Byte
L	×	×	×	H	H	V_{PPL}	V_{PPL}	V_{CC}	Output Disable	Hi-Z	Hi-Z	Byte
H	L	×	×	H	H	V_{PPL}	V_{PPL}	V_{CC}	Output Disable	Hi-Z	Hi-Z	Byte
L	H	L	L	H	H	V_{PPH}	V_{PPX}	V_{CC}	Program (×8)	Di (Even)	Don't care	Byte
L	H	H	L	H	H	V_{PPX}	V_{PPH}	V_{CC}	Program (×8)	Di (Odd)	Don't care	Byte
L	L	×	L	H	H	V_{PPH}	V_{PPH}	V_{CC}	Program (×16)	Di (Even)	Di (Odd)	Word
H	L	×	L	H	H	V_{PPX}	V_{PPH}	V_{CC}	Program (×8)	Don't care	Di (Odd)	Byte
L	H	L	H	L	H	V_{PPH}	V_{PPX}	V_{CC}	Verify (×8)	Do (Even)	Hi-Z	Byte
L	H	H	H	L	H	V_{PPX}	V_{PPH}	V_{CC}	Verify (×8)	Do (Odd)	Hi-Z	Byte
L	L	×	H	L	H	V_{PPH}	V_{PPH}	V_{CC}	Verify (×16)	Do (Even)	Do (Odd)	Word
H	L	×	H	L	H	V_{PPX}	V_{PPH}	V_{CC}	Verify (×8)	Hi-Z	Do (Odd)	Byte
L	H	H	L	L	H	V_{PPH}	V_{PPX}	V_{CC}	*1 Prohibited	—	—	—
L	H	L	L	L	H	V_{PPX}	V_{PPH}	V_{CC}	*1 Prohibited	—	—	—
L	L	×	L	L	H	V_{PPH}	V_{PPH}	V_{CC}	*1 Prohibited	—	—	—
H	L	×	L	L	H	V_{PPX}	V_{PPH}	V_{CC}	*1 Prohibited	—	—	—

*1. Do not use this mode as it will result in write errors.

H : High L : Low × : Don't Care
 Di : Input Data Do : Output Data Hi-Z : High Impedance
 V_{CC} : 4.5 ~ 5.5V V_{PPL} : 0.0 ~ 1.5V V_{PPH} : 11.4 ~ 12.6V
 V_{PPX} : V_{PPL} or V_{PPH}

Caution: When the write Protect switch is in protect-mode, the WP signal is "HIGH" and write operation are not allowed.

5.3 Software Command (8/16 Bits Operation () : 16 Bits Operation)

Command	Bus Cycles	First Bus Cycle			Second Bus Cycle			
		Operation	Address	Data	Operation	Address	Data Input	Data Output
Read Array/Reset	1	Write	RA	FFH/ (FFFFH)	—	—	—	—
Read Intelligent Identifier	3	Write	DA	90H/ (9090H)	Read	IA	—	IID
Read Status Register	2	Write	DA	70H/ (7070H)	Read	DA	—	SRD
Clear Status Register	1	Write	DA	50H/ (5050H)	—	—	—	—
Erase Setup/Erase Confirm	2	Write	BA	20H/ (2020H)	Write	BA	D0H/ (D0D0H)	—
Erase Suspend/Erase Resume	2	Write	BA	B0H/ (B0B0H)	Write	BA	D0H/ (D0D0H)	—
Byte Write Setup/Write	2	Write	WA	40H/ (4040H)	Write	WA	WD	—
Alternate Byte Write Setup/Write	2	Write	WA	10H/ (1010H)	Write	WA	WD	—

Note) 1. This Table shows the basic from of Erase, Verify and Program Verify.

Refer Programming Flowchart, Erase Algorithm in detail.

2. Bus operations are defined in function table in page 6.

3. IA : Device Identifier Address IID : Device Identifier Data

	DA	IA			IID	
		8Bits (Even Device)	8Bits (Odd Device)	16Bits	Byte (8Bits)	Word (16Bits)
Manufacturer Code	000000H~1FFFFFFH	000000H	000001H	000000H	89H	8989H
Device Code	000000H~1FFFFFFH	000002H	000003H	000001H	A2H	A2A2H

RA : Read Address WA : Write Address WD : Write Data

DA : Device Address (Any Address in device is acceptable.)

BA : Erase Block Address (Erase Size is 64k Bytes.)

SRD : Status Register Data

4. Either 40H (4040H) or 10H (1010H) are recognized by the WSM as the Byte Write Setup Command.

a) Read Array/Reset Command: (FFH/FFFFH)

By writing this command, device. Devices pair become read mode. The device remains enable for reads until the Command User Interface contents are altered.

b) Intelligent Identifier Command: (90H/9090H):

After writing this command into the Command User Interface, a read cycle retrieves the manufacturer Code and device Code. To terminate the Operation, it is necessary to write another valid command into the register.

c) Read Status Register Command: (70H/7070H):

By Writing this command, the Status Register may be read at any time to determine when a byte or block erase operation is complete, and whether that operation completed successfully.

Refer to Status Register definition in page. 9. After writing this command, all subsequent read operations output data from the Status Register, until another valid command is written to the Command User Interface.

d) Clear Status Register Command: (50H/5050H)

Status bits which show error, the Erase Status (SR. 5), Byte Write Status (SR. 4) bits and the V_{PP} Status bit (SR. 3) can be reset by the Clear Status Machine Register Command.

e) Erase Setup/Erase Command: (20H/2020H) (D0H/D0D0H): Erase is executed one block (64kB for 1 device, 128kB for 2 devices) at a time.

This command is functional when $V_{PP} = V_{PPH}$ and an Erase Setup Command is first written to the Command User Interface, followed by the Erase Confirm Command. After that, the device automatically outputs Status Register data when read.

The CPU can detect the completion of the erase event by analyzing the output of the RDY/ \overline{BSY} pin, or the WSM Status bit of the Status Register. When erase is completed, the Erase Status bit should be checked. If erase error is detected, the Status Register should be cleared.

f) Erase Suspend/Erase Resume Command: (B0H/B0B0H) / (D0H/D0D0H)

The Erase Suspend command allows block erase interruption in order to read data from another block of memory. The device continues to output Status Register data when read, after the Erase Suspend Command is written. Polling the WSM Status and Erase Suspend Status bits will determine when the erase operation has been suspended. RDY/ \overline{BSY} pin will also transition to V_{OH} . At this point, a Read Array Command can be written to the Command User Interface to read data from blocks other than that which is suspended. V_{PP} must remain at V_{PPH} while device is in Erase Suspend.

Erase Resume Command, at which time the WSM will continue with the erase process. The Erase Suspend Status and WSM Status bits of the Status Register will be automatically cleared and RDY/ \overline{BSY} pin will return to V_{OL} . After the Erase Resume is written, the device automatically output Status Register data when read.

g) Byte Write Setup/Write Command: (40H/4040H) or (10H/1010H)

This command is functional when $V_{PP} = V_{PPH}$ and an Byte Write Setup Command is first written to the Command User Interface, followed by a second write specifying the address and data to be written. The WSM then take over, controlling the byte write and write verify algorithms internally. After the two command byte sequence is written to it, the device automatically outputs Status Register data when read. The CPU can detect the completion of the byte write event by analyzing the output of the RDY/ \overline{BSY} pin, or the WSM Status bits of the Status Register.

5.4 Status Register

The memory devices in this card have Status Register which shows state of the device.

Byte Access × 8 Bits

bit7	bit6	bit5	bit4	bit3	bit2	bit1	bit0
SR.7	SR.6	SR.5	SR.4	SR.3	SR.2	SR.1	SR.0
WSMS	ESS	ES	BWS	VPPS	RFU	RFU	RFU

Register	Contents
SR.7=Write State Machine Status 1=Ready 0=Busy	When set "1" s, read, erase, data write is acceptable.
SR.6=Erase Suspend Status 1=Erase Suspend 0=Erase In Progress/Completed	Check whether Erase Suspend Command is executed or not.
SR.5=Erase Status 1=Error In Block Erase 0=Successful Block Erase	Set "1" s when fail to Erase. Reset by the Clear Status Register Command.
SR.4=Byte Write Status 1=Error In Byte Write 0=Successful Byte Write	Set "1" s when fail to Byte Write. Reset by the Clear Status Register Command.
SR.3=V _{pp} Status 1=V _{pp} Low Detect ; Operation Abort 0=V _{pp} OK	Set "1" s when V _{pp} , which is needed in Byte Write or Erase operation, is below V _{ppH} . Reset by the Clear Status Register Command.
SR.2~SR.0=Reserved for Future Use	

Word Access × 16 bits

bit15							bit8	bit7							bit0
SR.15	SR.14	SR.13	SR.12	SR.11	SR.10	SR.9	SR.8	SR.7	SR.6	SR.5	SR.4	SR.3	SR.2	SR.1	SR.0
Odd Byte device								Even Byte device							

5.5 Programming Flowchart

(Byte Mode)

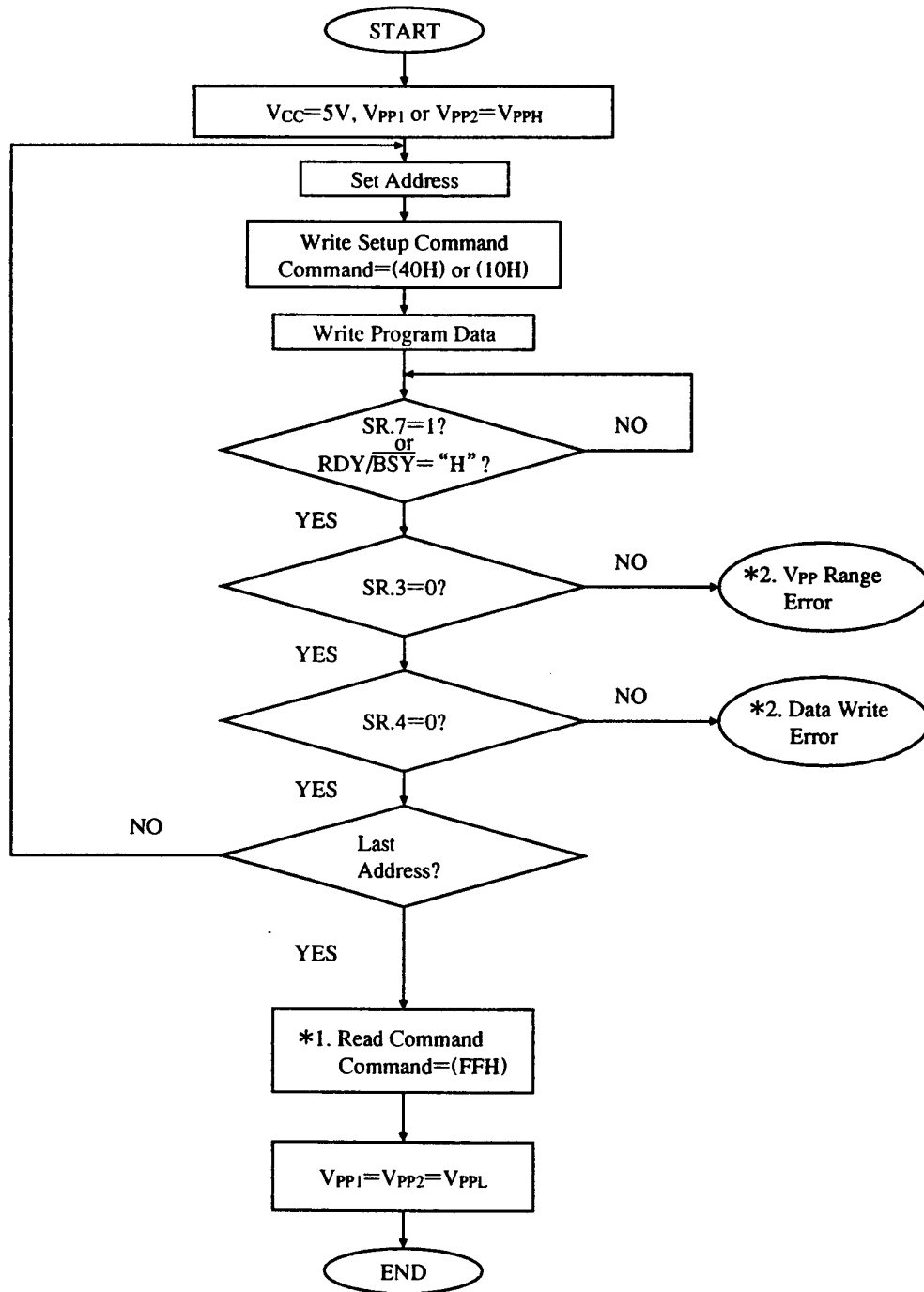

Note) * 1. Write FFH after the last block write operation to reset the device to Read Array Mode.

* 2. If error is detected, clear the Status Register before attempting retry or other error recovery.

Programming Flowchart
(Word Mode)

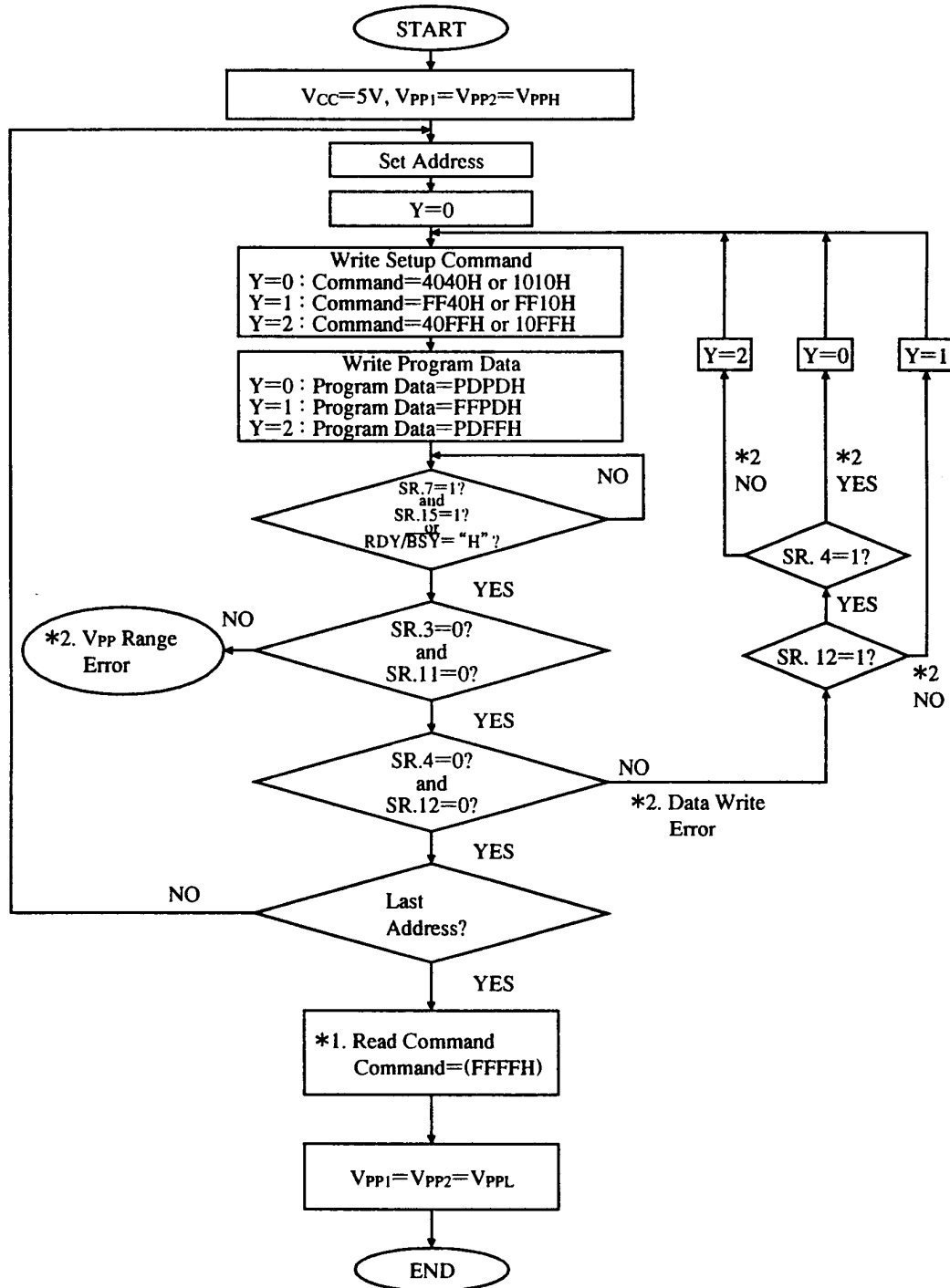

Note) *1. Write FFFFH after the last block write operation to reset the device to Read Array Mode.
 *2. If error is detected, clear the Status Register before attempting retry or other error recovery.

5.6 Erase Algorithm

(Byte Mode)

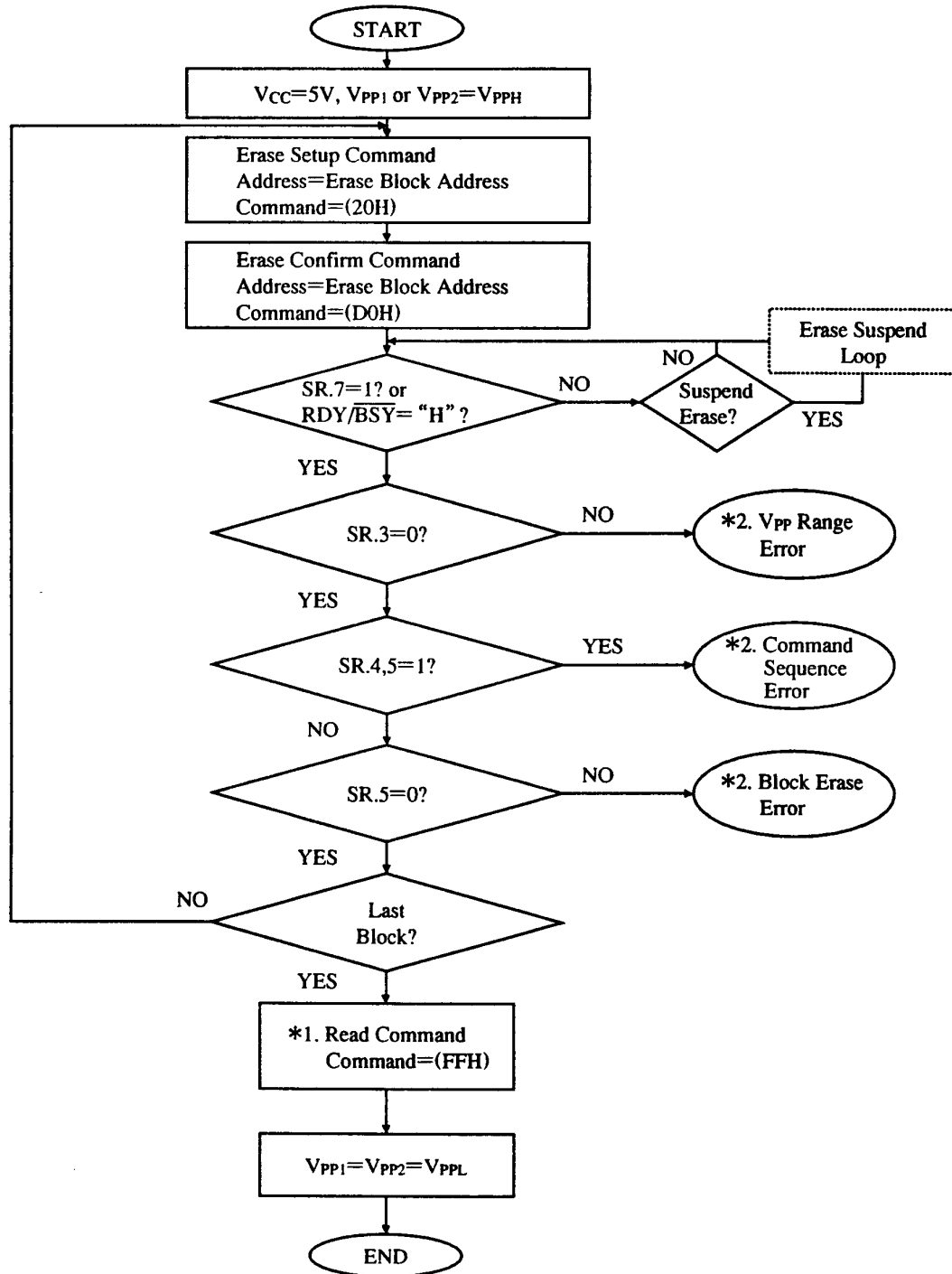

Note) *1. Write FFH after the last block erase operation to reset the device to Read Array Mode.

*2. If error is detected, clear the Status Register before attempting retry or other error recovery.

Erase Algorithm
(Word Mode)

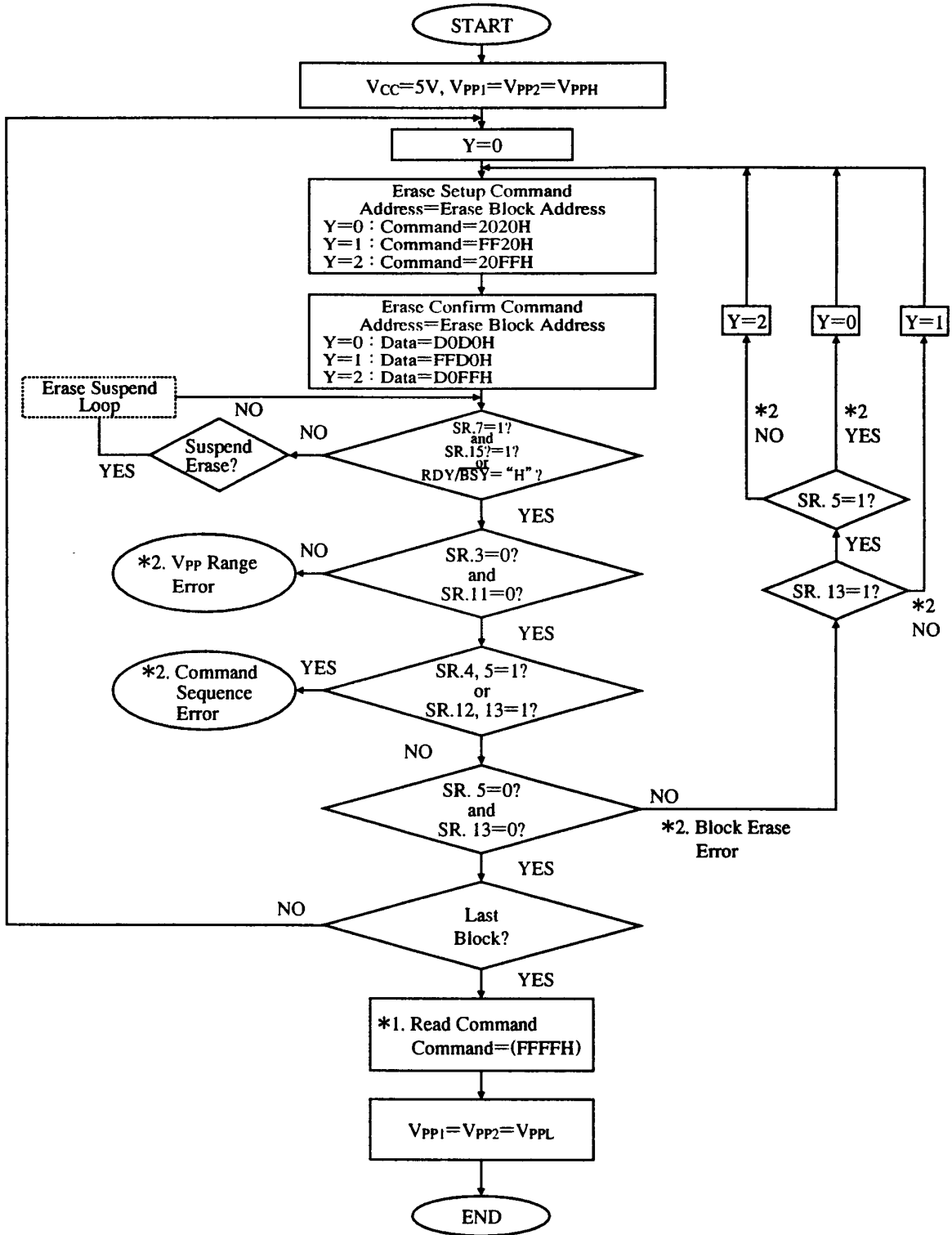

Note) * 1. Write FFFFH after the last block erase operation to reset the device to Read Array Mode.
 * 2. If error is detected, clear the Status Register before attempting retry or other error recovery.

6. Absolute Maximum Ratings

PARAMETER	SYMBOL	RATING	UNIT
Supply Voltage	V_{CC}	-0.3 to 7.0	V
Input Voltage	V_{IN}	-0.3 to $V_{CC}+0.3$ (Max : 7.0)	V
Output Voltage	V_{OUT}	-0.3 to $V_{CC}+0.3$ (Max : 7.0)	V
Operating Temperature	T_{OPR}	0 to +60	°C
Storage Temperature	T_{STG}	-20 to +65	°C

7. Recommended Operating Conditions

PARAMETER	SYMBOL	Min.	Max.	UNIT
Operating Temperature	T_{OPR}	0	+60	°C
Supply Voltage	V_{CC}	4.5	5.5	V
Input Voltage High	V_{IH}	3.5	$V_{CC}+0.3$	V
Input Voltage Low	V_{IL}	-0.3	1.5	V

8. Capacitance

PARAMETER	SYMBOL	Min.	TYP	Max.	UNIT	CONDITION
Input Capacitance	C_{IN}	—	17	—	pF	$V_{CC}=5V\pm 10\%$ $f=1MHz, T_a=25^\circ C$
Input/Output Capacitance	C_{IO}	—	17	—	pF	

9. Read Operation

9.1 DC Characteristics

($V_{CC}=4.5\sim 5.5V$, $T_a=0\sim 60^\circ C$)

PARAMETER		SYMBOL	Min.	TYP	Max.	UNIT	CONDITION
Operating Voltage	High Temperature	V_{CC}	4.5	—	5.5	V	
	Low Temperature						
Current Consumption *1	Static Operatin Current	I_{SB}	—	—	2.0	mA	X16, Address : PingPong
	Dynamic Operating Current	I_{CC}	—	—	80		
Input Voltage	Input Voltage Level High	V_{IH}	3.5	—	$V_{CC}+0.3$	V	$V_{CC}=4.5\sim 5.5V$
	Input Voltage Level Low	V_{IL}	-0.3	—	1.5		
Input Current	$A_0\sim A_{20}, D_0\sim D_{15}$	$I_{i,1}$	-10	—	70	μA	$V_i = V_{CC}, 0V$
	$\overline{CE}_1, \overline{CE}_2, \overline{OE}, \overline{WE}, \overline{REG}$		-70	—	10		
Output Voltage	High	V_{OH}	$V_{CC}\sim 0.5$	—	—	V	$I_{OH} = -2mA (*^2)$ $I_{OH} = -4\mu A (*^3)$
	Low	V_{OL}	—	—	0.4		$I_{OL} = 4mA$

PingPong : Scan the target address, with accessing the target and another address alternately.

*1 (1) Static Operating Current : With the memory card's voltage at 5.5V and the $\overline{CE}_1, \overline{CE}_2, \overline{OE}, \overline{WE}$ and \overline{REG} signals "HIGH" ($V_{IH} = V_{CC} - 0.2V$), A_0 signal "LOW" ($V_{IL} \leq 0.2V$) the current consumption is measured with the output open.

(2) Dynamic Operating Current : With the memory card's V_{CC} at 5.5V and $V_{PP1} = V_{PP2}$ at 12.6V, current consumption during access is measured with the output open.

(Access time : 200ns) The current depends on addressing.

*2 $D_0\sim D_{15}$

*3 $BVD_1, BVD_2, RDY/\overline{BSY}, WP$

9.2 AC Characteristics ($V_{CC}=4.5\sim 5.5V$, $V_{PP}=0.0\sim 1.5V$, $T_a=0\sim 60^\circ C$)

Testing Conditions:

- 1) Input Pulse Level : 0.8~3.5V
- 2) Input Rise/Fall Time : 10ns
- 3) Input/Output Timing Reference Level : 1.5V
- 4) Output Load : 1TTL + C_L (100pF) (including scope and jig capacitance)

9.2.1 Read Cycle

($V_{CC}=4.5\sim 5.5V$, $V_{PP}=0.0\sim 1.5V$, $T_a=0\sim 60^\circ C$)

PARAMETER	SYMBOL	SYMBOL (PCMCIA)	Min.	Max.	UNIT
Read Cycle Time	t_{AVAV}	t_{cR}	200	—	ns
Address Access Time	t_{AVQV}	$t_a (A)$	—	200	
Card Enable Access Time	t_{ELQV}	$t_a (CE)$	—	200	
Output Enable Access Time	t_{GLQV}	$t_a (OE)$	—	100	
Output Disable Time from $\overline{CE} *$	t_{EHQV}	$t_{dis} (CE)$	—	90	
Output Disable Time from $\overline{OE} *$	t_{GHQZ}	$t_{dis} (OE)$	—	90	
Output Enable Time from \overline{CE}	t_{ELQX}	$t_{en} (CE)$	5	—	
Output Enable Time form \overline{OE}	t_{GLQX}	$t_{en} (OE)$	5	—	
Data Valid from Add Change		$t_v (A)$	0	—	

* Time until output becomes floating. (The output voltage is not defined.)

○Read CYCLE (1) ($\overline{CE}_2 = V_{IH}$ Fixed), 8bits Output

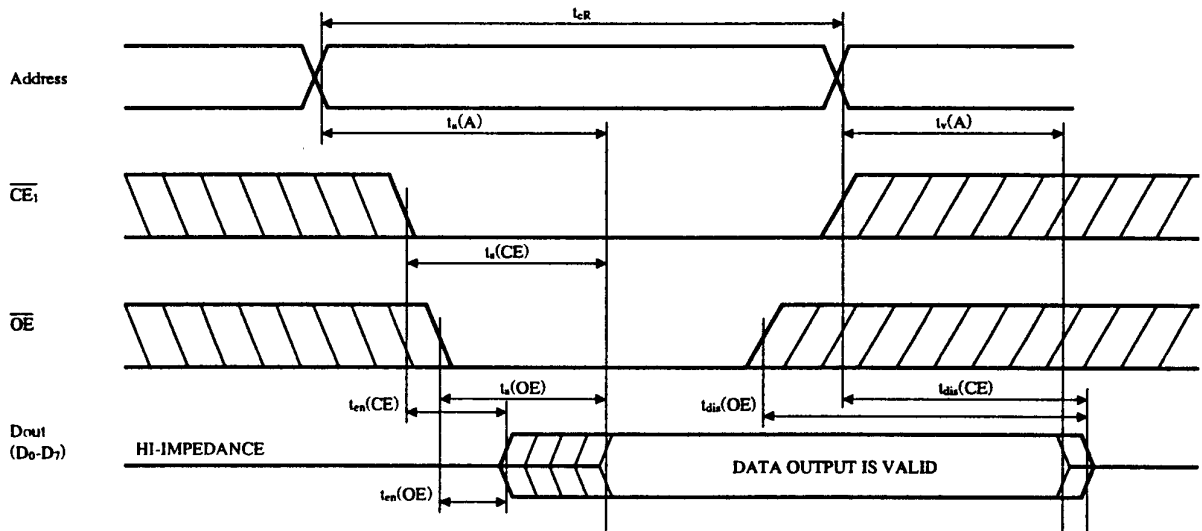

- Note) 1. $\overline{WE} = \text{"HIGH"}$, during a read cycle.
 2. Either "HIGH" or "LOW" in diagonal areas.
 3. The output data becomes valid when last interval, $t_A(A)$, $t_A(CE)$ or $t_A(CE)$ have concluded.

○Read Cycle (2) ($\overline{CE}_1 = V_{IH}$ Fixed), 8Bits Output

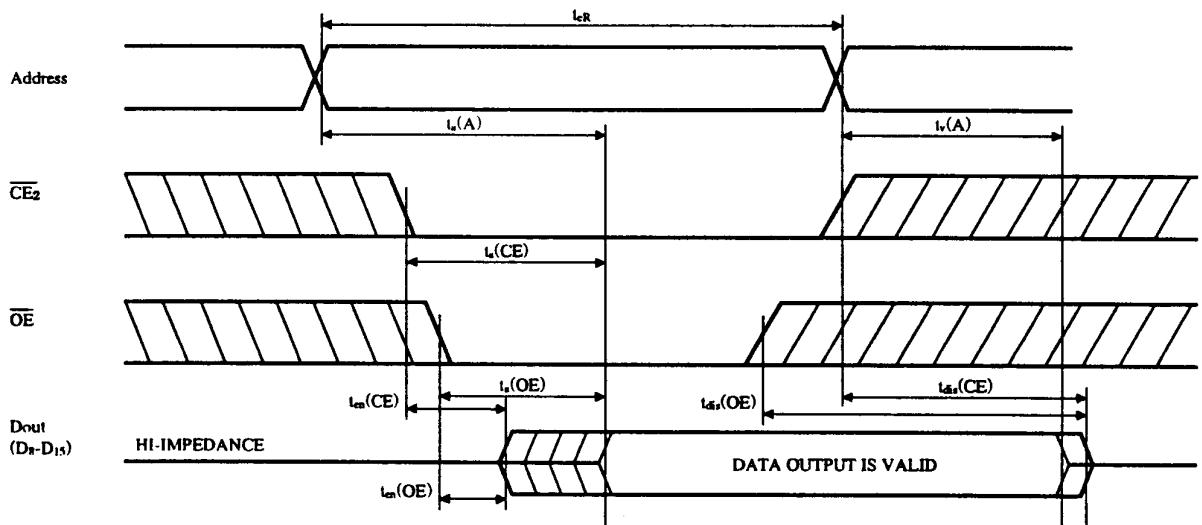

- Note) 1. $\overline{WE} = \text{"HIGH"}$, during a read cycle.
 2. Either "HIGH" or "LOW" in diagonal areas.
 3. The output data becomes valid when last interval, $t_A(A)$, $t_A(CE)$ or $t_A(CE)$ have concluded.

○Read Cycle (3), 16Bits Output

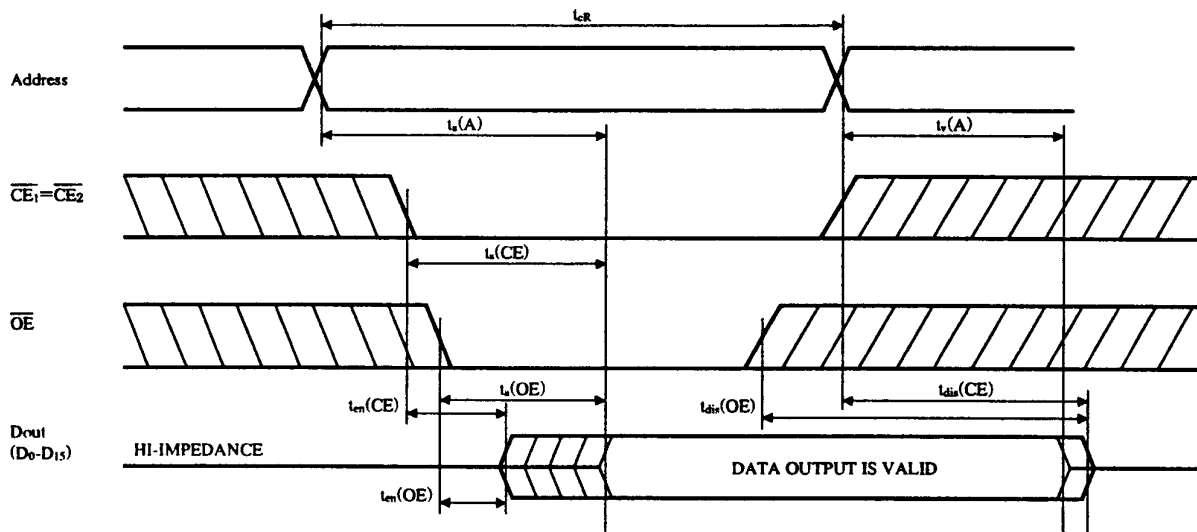

- Note) 1. \overline{WE} = "HIGH", during a read cycle.
 2. Either "HIGH" or "LOW" in diagonal areas.
 3. Change \overline{CE}_1 and \overline{CE}_2 at the same time.
 4. The output data becomes valid when last interval, $t_L(A)$, $t_L(CE)$ or $t_L(CE)$ have concluded.

10. Programming Operation

10.1 DC Characteristics

($V_{CC}=4.5\sim 5.5V$, $V_{PP}=11.4\sim 12.6V$, $T_a=0\sim 60^\circ C$)

PARAMETER	SYMBOL	Min.	Max.	UNIT	CONDITION	
V_{PP1} , V_{PP2} operating Voltage	Read	V_{PPL}	0	1.5	V	
	Program	V_{PPH}	11.4	12.6		
V_{PP1} , V_{PP2} operating Current ($\times 16$ Mode)	Read	I_{SB2}	—	1.6	mA	Input open
	Program	I_{PP}	—	20		RMS
V_{CC} operating Current	Standby Program	I_{SB1}	—	2	V	Input open
		I_{CC}	—	75		RMS
Input Voltage	V_{IL}	-0.3	1.5	V		
	V_{IH}	3.5	$V_{CC}+0.3$			
Output Voltage During Verify	V_{OL}	—	0.4	V	$I_{OL}=4mA$	
	V_{OH}	$V_{CC}-0.5$	—		$I_{OH}=-2mA$	

- Note) 1. Power on V_{CC} before power on V_{PP} , power off V_{CC} after power off V_{PP} .
 2. Keep V_{PP} including its overshoot, below 13V.
 3. Card insertion or removal while applying $V_{PP}=12V$ may cause a loss of integrity.
 4. Do not turn on or turn off during $\overline{CE} = "LOW"$.
 5. If V_{IH} goes above $V_{CC}+0.3V$, normal operation is not assured.

10.2 AC Characteristics ($V_{CC}=4.5\sim 5.5V$, $V_{PP}=11.4\sim 12.6V$, $T_a=0\sim 60^\circ C$)

Testing Conditions:

- 1) Input Pulse Level : 0.8~3.5V
- 2) Input Rise/Fall Time : 10ns
- 3) Input/Output Timing Reference Level : 1.5V
- 4) Output Load : 1TTL + C_L (100pF) (including scope and jig capacitance)

10.2.1 Program Cycle

 \overline{WE} Controlled($V_{CC}=4.5\sim 5.5V$, $V_{PP}=11.4\sim 12.6V$, $T_a=0\sim 60^\circ C$)

PARAMETER	SYMBOL	SYMBOL (PCMCIA)	Min.	Max.	UNIT
Write Cycle Time	t_{AVAV}	t_{cW}	200	—	ns
Address Setup Time	t_{AVWL}	$t_{su}(A)$	20	—	
Write Recovery Time	t_{WHAX}	$t_{rec}(WE)$	30	—	
Data Setup Time for \overline{WE}	t_{DVWH}	$t_{su}(D-WEH)$	60	—	
Data Hold Time	t_{WHDX}	$t_h(D)$	30	—	
Write Recovery Before Read	t_{WHGL}		10	—	
Card Enable Setup time for \overline{WE}	t_{ELWH}	$t_{su}(CE-WEH)$	140	—	
Address Setup for \overline{WE}	t_{AVWH}	$t_{su}(A-WEH)$	140	—	
Card Enable Hold Time	t_{WHEH}		15	—	
Write Pulse Width	t_{WLWH}	$t_w(WE)$	120	—	
Write Pulse Width High	t_{WHWL}	$t_w(WEH)$	30	—	
\overline{WE} High to RDY/BSY Going Low	t_{WHRL}		—	150	
Duration of write operation	t_{WHQV1}		4.8	—	μs
V_{PP} Setup to \overline{WE} Going High	t_{VPWH}		100	—	ns
V_{PP} Hold from Valid SRD, RDY/BSY High	t_{QVVL}		0	—	

 \overline{CE} Controlled($V_{CC}=4.5\sim 5.5V$, $V_{PP}=11.4\sim 12.6V$, $T_a=0\sim 60^\circ C$)

PARAMETER	SYMBOL	SYMBOL (PCMCIA)	Min.	Max.	UNIT
Write Cycle Time	t_{AVAV}	t_{cW}	200	—	ns
Address Setup Time	t_{AVEL}	$t_{su}(A)$	20	—	
Write Recovery Time	t_{EHAX}	$t_{rec}(CE)$	30	—	
Data Setup Time for \overline{CE}	t_{DVEH}	$t_{su}(D-CEH)$	60	—	
Data Hold Time	t_{EHDX}	$t_h(D)$	30	—	
Write Recovery Before Read	t_{EHGL}		10	—	
Write Enable Setup time for \overline{CE}	t_{WLEH}	$t_{su}(WE-CEH)$	140	—	
Address Setup for \overline{CE}	t_{AVEH}	$t_{su}(A-CEH)$	140	—	
Write Enable Hold Time	t_{EHWL}		0	—	
Write Pulse Width	t_{ELEH}	$t_w(CE)$	120	—	
Write Pulse Width High	t_{EHEL}	$t_w(CEH)$	30	—	
\overline{WE} High to RDY/BSY Going Low	t_{EHRL}		—	150	
Duration of write operation	t_{EHQV1}		4.8	—	μs
V_{PP} Setup to \overline{WE} Going High	t_{VPEH}		100	—	ns
V_{PP} Hold from Valid SRD, RDY/BSY High	t_{QVVL}		0	—	

1. Set \overline{CE}_1 , \overline{CE}_2 , \overline{OE} and \overline{WE} "HIGH", when V_{PP} changes from V_{PPL} to V_{PPH} or vice versa.

Program Cycle (WE Controlled)

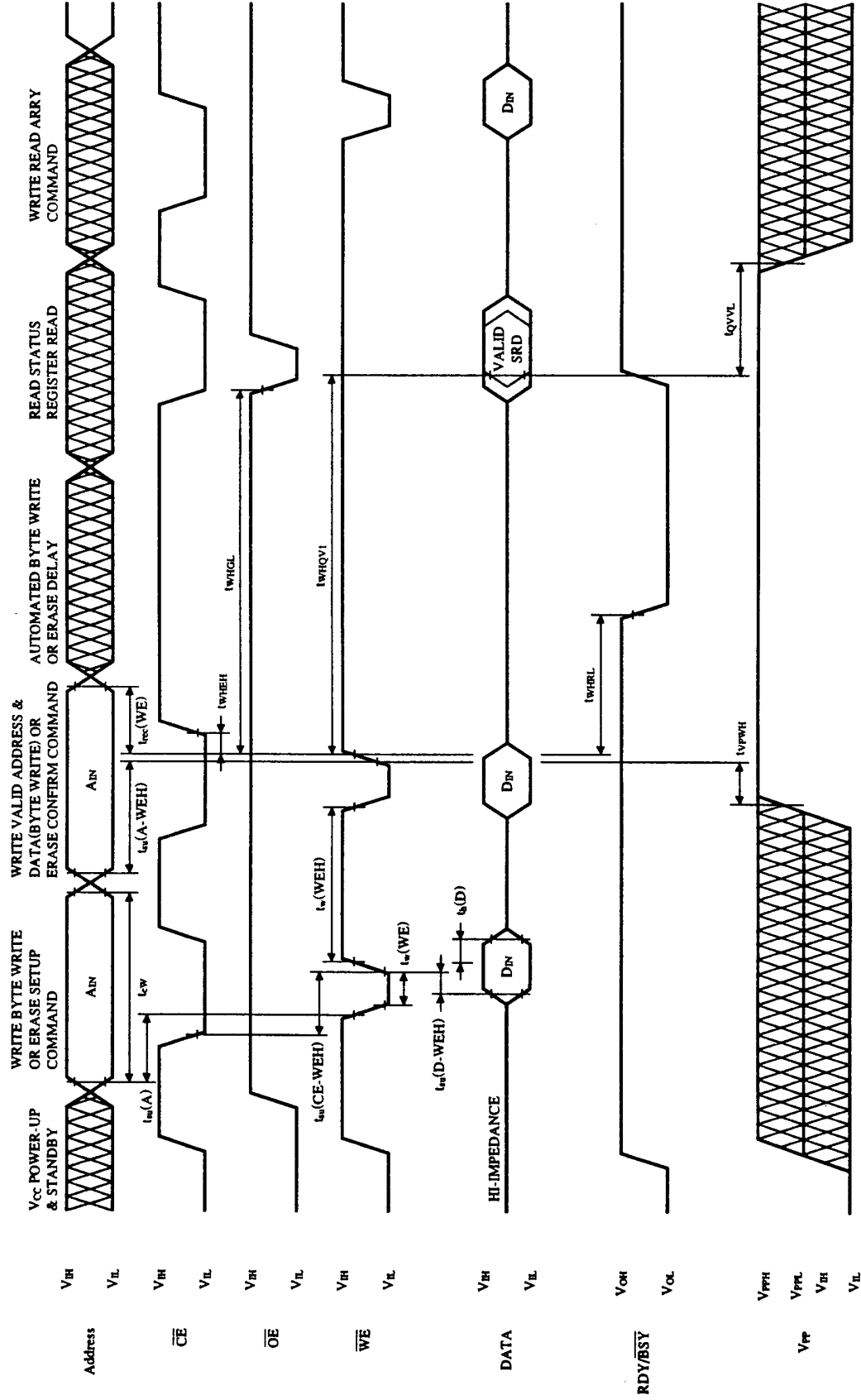

Note) While the data signal is in output mode, do not apply an opposite phase signal.

11. Erase Operation

11.1 DC Characteristics

($V_{CC}=4.5\sim 5.5V$, $V_{PP}=11.4\sim 12.6V$, $T_a=0\sim 60^\circ C$)

PARAMETER	SYMBOL	Min.	Max.	UNIT	CONDITION	
V_{PP1} , V_{PP2} Operating Voltage	Read	V_{PPL}	0	1.5	V	
	Program	V_{PPHE}	11.4	12.6		
V_{PP1} , V_{PP2} Operating Current ($\times 16$ Mode)	Standby	I_{SB2}	—	1.6	mA	I/O open
	Erase	I_{PP}	—	20		RMS
	Erase Suspend	I_{PPS}	—	1.6		$\overline{CE}_1, \overline{CE}_2 = V_{IH}$, RMS
V_{CC} Operating Current ($\times 16$ Mode)	Standby	I_{SB1}	—	2.0	V	I/O open
	Erase	I_{CCE}	—	75		RMS
	Erase Suspend	I_{CCEs}	—	22		$\overline{CE}_1, \overline{CE}_2 = V_{IH}$, RMS
Input Voltage		V_{IL}	-0.3	1.5	V	
		V_{IH}	3.5	$V_{CC}+0.3$		
Output Voltage During Verify		V_{OL}	—	0.4	V	$I_{OL}=4mA$
		V_{OH}	$V_{CC}-0.5$	—		$I_{OH}=-2mA$

Note) Power on V_{CC} before power on V_{PP} , power off V_{CC} after power off V_{PP} . Keep V_{PP} including its overshoot, below 13V Card insertion or removal while applying $V_{PP}=12V$ may cause a loss of integrity. Do not turn on or turn off during $\overline{CE} = "LOW"$.

If V_{IH} goes above $V_{CC}+0.3V$, normal operation is not assured.

11.2 AC Characteristics ($V_{CC}=4.5\sim 5.5V$, $V_{PP}=11.4\sim 12.6V$, $T_a=0\sim 60^\circ C$)

Testing Conditions:

- 1) Input Pulse Level : 0.8~3.5V
- 2) Input Rise/Fall Time : 10ns
- 3) Input/Output Timing Reference Level : 1.5V
- 4) Output Load : 1TTL + C_L (100pF) (including scope and jig capacitance)

11.2.1 Erase Cycle

\overline{WE} Controlled

($V_{CC}=4.5\sim 5.5V$, $V_{PP}=11.4\sim 12.6V$, $T_a=0\sim 60^\circ C$)

PARAMETER	SYMBOL	SYMBOL (PCMCIA)	Min.	Max.	UNIT
Write Cycle Time	t_{AVAV}	t_{cw}	200	—	ns
Address Setup Time	t_{AVWL}	$t_{su}(A)$	20	—	
Write Recovery Time	t_{WHAX}	$t_{rec}(WE)$	30	—	
Data Setup Time for \overline{WE}	t_{DVWH}	$t_{su}(D-WEH)$	60	—	
Data Hold Time	t_{WHDX}	$t_h(D)$	30	—	
Write Recovery Before Read	t_{WHGL}		10	—	
Card Enable Setup time for \overline{WE}	t_{ELWH}	$t_{su}(CE-WEH)$	140	—	
Address Setup for \overline{WE}	t_{AVWH}	$t_{su}(A-WEH)$	140	—	
Card Enable Hold Time	t_{WHEH}		15	—	
Write Pulse Width	t_{WLWH}	$t_w(WE)$	120	—	
Write Pulse Width High	t_{WHWL}	$t_w(WEH)$	30	—	
\overline{WE} High to RDY/ \overline{BSY} Going Low	t_{WHRL}		—	150	
Duration of Erase operation	t_{WHQV2}		0.3	—	
V_{PP} Setup to \overline{WE} Going High	t_{VPWH}		100	—	ns
V_{PP} Hold from Valid SRD, RDY/ \overline{BSY} High	t_{QVVL}		0	—	

\overline{CE} Controlled $(V_{CC}=4.5\sim 5.5V, V_{PP}=11.4\sim 12.6V, T_a=0\sim 60^\circ C)$

PARAMETER	SYMBOL	SYMBOL (JEIDA)	Min.	Max.	UNIT
Write Cycle Time	t_{AVAV}	t_{cw}	200	—	ns
Address Setup Time	t_{AVEL}	$t_{su} (A)$	20	—	
Write Recovery Time	t_{EHAX}	$t_{rec} (CE)$	30	—	
Data Setup Time for \overline{CE}	t_{DVEH}	$t_{su} (D-CEH)$	60	—	
Data Hold Time	t_{EHDX}	$t_h (D)$	30	—	
Write Recovery Before Read	t_{EHGL}		10	—	
Write Enable Setup time for \overline{CE}	t_{WLEH}	$t_{su} (WE-CEH)$	140	—	
Address Setup for \overline{CE}	t_{AVEH}	$t_{su} (A-CEH)$	140	—	
Write Enable Hold Time	t_{EHW1}		0	—	
Write Pulse Width	t_{ELEH}	$t_w (CE)$	120	—	
Write Pulse Width High	t_{EHEL}	$t_w (CEH)$	30	—	
\overline{WE} High to $\overline{RDY}/\overline{BSY}$ Going Low	t_{EJRL}		—	150	
Duration of Erase operation	t_{EIQV2}		0.3	—	s
V_{PP} Setup to \overline{WE} Going High	t_{VPEH}		100	—	ns
V_{PP} Hold from Valid $\overline{SRD}, \overline{RDY}/\overline{BSY}$ High	t_{QVVL}		0	—	

1. Set $\overline{CE}_1, \overline{CE}_2, \overline{OE}$ and \overline{WE} "HIGH", when V_{PP} changes from V_{PPL} to V_{PPH} or vice versa.

OPERASE CYCLE (\overline{CE} Controlled)

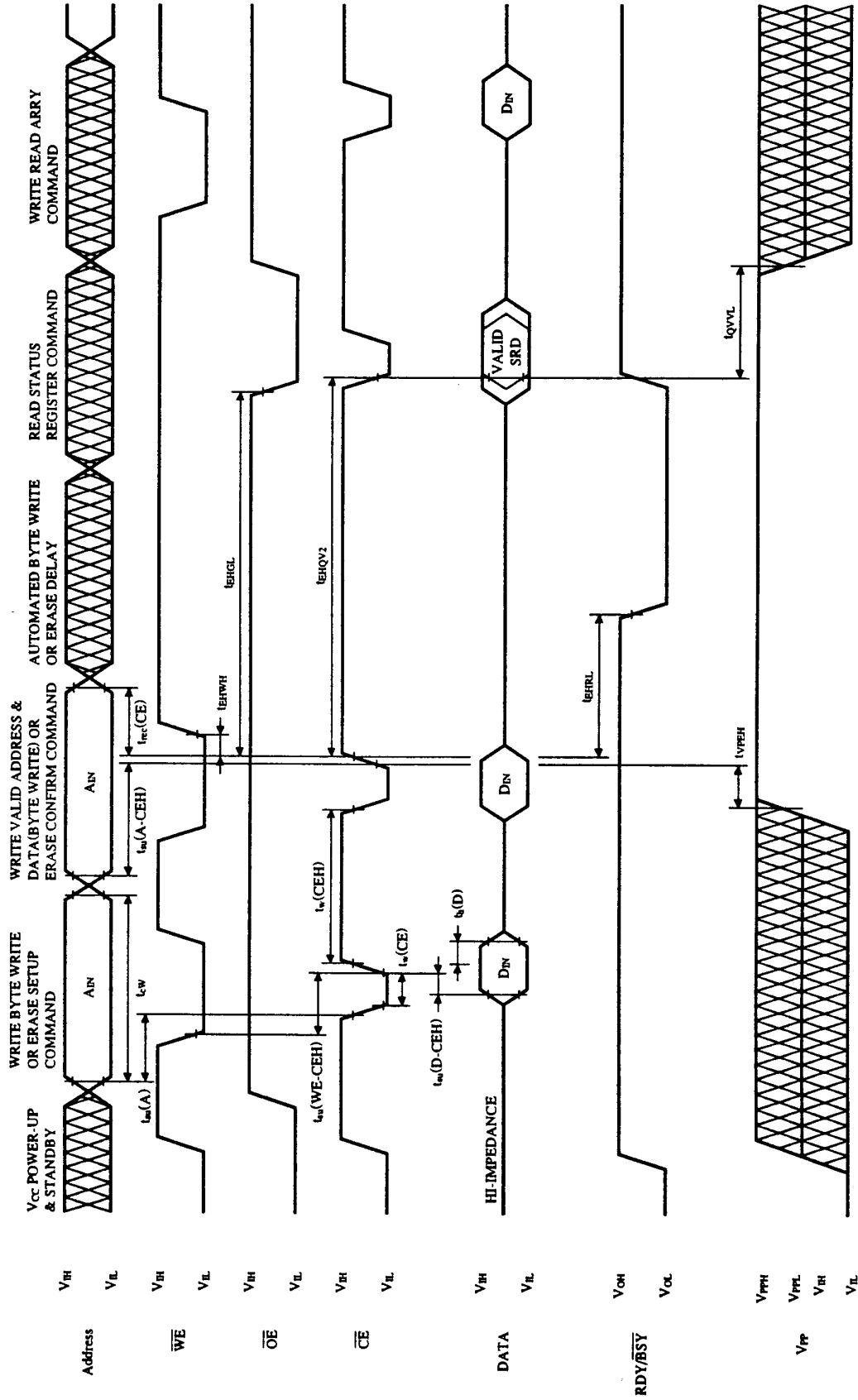

Note) While the data signal is in output mode, do not apply an opposite phase signal.

12. Block Erase and Data Write Characteristics

(V_{CC}=4.5~5.5V, V_{PP}=11.4~12.6V, Ta=0~60°C)

PARAMETER	Min.	Typ.	Max.	UNIT
Block Pair Erase Time	—	1.0	10	s
Block Pair Write Time	—	0.4	2.1	

13. Voltage Timing (Ta=25°C)

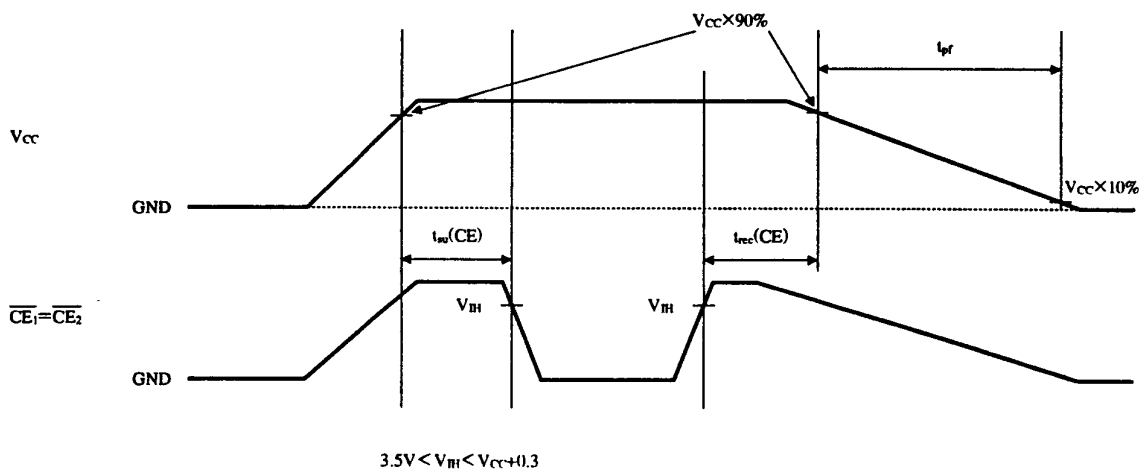

PARAMETER	SYMBOL	Min.	Max.	UNIT
\overline{CE} Setup Time	$t_{su}(CE)$	4.0	—	ms
\overline{CE} Recovery Time	$t_{rec}(CE)$	1.0	—	μ s
V _{CC} Falling Time	t_{pf}	3.0	300	ms

Note) 1. When V_{CC} (4.5~5.5V) is applied to the memory card and you are inserting or removing the card, \overline{CE}_1 , \overline{CE}_2 should both be high-impedance. At such a time, other signal line should also be hi-impedance. After inserting the memory card, do not access it during the \overline{CE} setup time (minimum of 4ms).

(During this time, neither \overline{CE}_1 nor \overline{CE}_2 = "LOW" .)

2. When V_{CC} is turn on, if the condition (for example, V_{CC} rising time. etc) is not sufficient to as specified, it is possible that device's Status Register is not cleared or device not becomes to Read Array Mode. To prevent these, it is recommended that using software command, reset the Status Register or set the device to Read Array Mode.

ex.

Reset the Status Register 50H (5050H)

Set to Read Array Mode FFH (FFFFH)

14. Attribute Memory

The attribute memory holds the attribute information of the card such as the type of card, bit configuration, speed and so on.

EEPROM Model

Card has 2k bytes of EEPROM attribute memory. To read the attribute memory, set \overline{REG} = "LOW" and perform a read with the same access timing as common memory read.

For this operation, access time is 300ns maximum. To allow 2k bytes of attribute memory, even addresses from 0 to 4096 are reserved. Since only the even-numbered bytes are used, reading odd-numbered bytes will result in invalid data.

Note) We have another type of attribute memory as follows,

No EEPROM Model. (Model no.ID240D02:5 bytes device informations in even address 0 to 8, read only in card's control circuit, with the same access timing as common memory read.)

14.1 Attribute Memory Read/Write Function Chart

\overline{CE}_1	\overline{CE}_2	A_0	\overline{WE}	\overline{OE}	\overline{REG}	MODE	$D_0 \sim D_7$	$D_8 \sim D_{15}$	STAATUS
H	H	X	X	X	X		High-Z	High-Z	Standby
L	H	L	H	L	L	Read (×8)	D_0 (even byte)	High-Z	Byte Access
L	H	H	H	L	L		High-Z	High-Z	Standby
L	L	X	H	L	L	Read (×8)	D_0 (even byte)	High-Z	Byte Access
H	L	X	H	L	L		High-Z	High-Z	Standby
L	H	L	L	H	L	Write (×8)	D_1 (even byte)	×××	Byte Access
L	H	H	L	H	L		×××	×××	Standby
L	L	X	L	H	L	Write (×8)	D_1 (even byte)	×××	Byte Access
H	L	X	L	H	L		×××	×××	Standby
L	X	X	H	L	L	Attribute Memory Address 0~8	D_0	High-Z	Byte Access

H : High

L : Low

X : High/Low not applicable

Di : Input Data

Do : Output Data

Hi-Z : High Impedance ××× : Don't Care

Notes : 1) When the write protect switch is in protect-mode, the WP output signal is "HIGH" and write operations (including attribute memory) are not allowed.

2) $A_0 \sim A_{11}$ are attribute memory address. Addresses after A_{12} are not decoded, so care should be taken.

14.2 AC Characteristics ($V_{CC} = 4.5V \sim 5.5V$, $T_a = 0 \sim 60^\circ C$)

Testing Conditions

- 1) Input Pulse Level : 0.8~3.5V
- 2) Input Rise/Fall Time : 10ns
- 3) Input/Output Timing Reference Level : 1.5V
- 4) Output Load Capacitance : 1TTL + C_L (100pF)
(including scope and jig capacitance)

14.3 Attribute Memory Read Cycle

 $(V_{CC}=4.5\sim 5.5V, T_a=0\sim 60^{\circ}C)$

PARAMETER	SYMBOL	SYMBOL (PCMCIA)	Min.	Max.	UNIT
Read Cycle Time	t_{CR}	t_{cR}	300	—	ns
Address Access Time	t_{ACC}	$t_a(A)$	—	300	
Card Enable Access Time	t_{CE}	$t_a(CE)$	—	300	
Output Enable Access Time	t_{OE}	$t_a(OE)$	—	150	
Output Disable Time from \overline{CE}		$t_{dis}(CE)$	—	100	
Output Disable Time from \overline{OE}	t_{DF}	$t_{dis}(OE)$	—	100	
Output Enable Time from \overline{CE}		$t_{en}(CE)$	5	—	
Output Enable Time from \overline{OE}		$t_{en}(OE)$	5	—	
Data Valid from Add Change	t_{OH}	$t_v(A)$	0	—	

○Attribute Memory Read Cycle

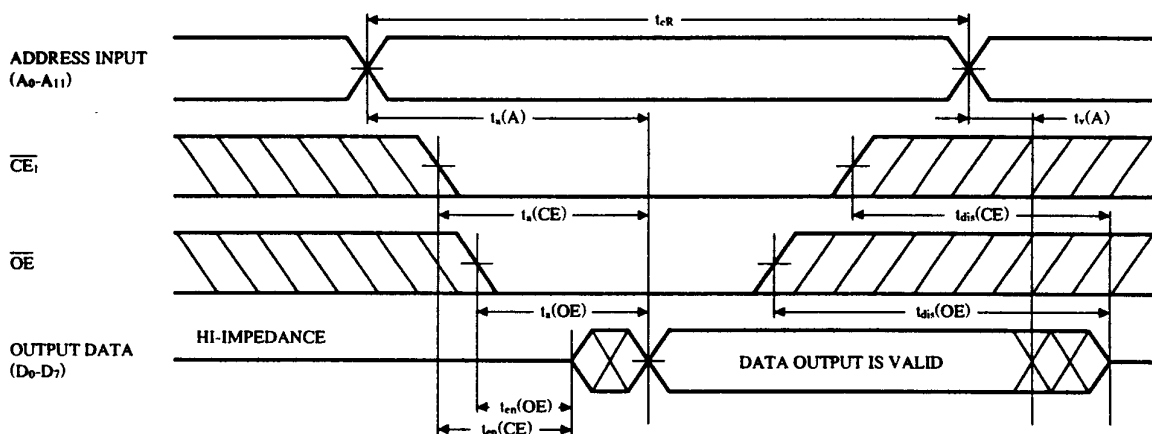

Note: 1. To read attribute memory, $\overline{REG} = \text{"LOW"}$, $\overline{WE} = \text{"HIGH"}$ and either $\overline{CE}_2 = \text{"LOW"}$ or else $\overline{CE}_2 = \text{"HIGH"}$ and $A_0 = \text{"LOW"}$.

2. The output data becomes valid when last interval, $t_a(A)$, $t_a(CE)$ or $t_a(OE)$ have concluded.

14.4 Attribute Memory Write Cycle

WE Controlled

(V_{CC}=4.5V~5.5V, T_a=0~60°C)

PARAMETER	SYMBOL	SYMBOL (PCMCIA)	Min.	Max.	UNIT
Write Cycle Time	t _{wc}	t _{cw}	10	—	ms
Write Pulse Width	t _{wp}	t _w (WE)	180	—	ns
Address Setup Time	t _{as}	t _{su} (A)	10	—	
Data Setup Time for $\overline{\text{WE}}$	t _{ds}	t _{su} (D-WEH)	100	—	
Card Enable Setup Time	t _{ces}	t _{su} (CE)	0	—	
Output Enable Setup Time	t _{oes}	t _{su} (OE-WE)	45	—	
Address Hold Time	t _{ah}		260	—	
Write Hold Time	t _{ch}		0	—	
Output Enable Hold Time	t _{oeh}		70	—	
$\overline{\text{WE}}$ HIGH Hold Time	t _{weh}		9.9	—	
Data Hold Time	t _{dh}	t _h (D)	80	—	ns

 $\overline{\text{CE}}$ Controlled(V_{CC}=4.5V~5.5V, T_a=0~60°C)

PARAMETER	SYMBOL	SYMBOL (PCMCIA)	Min.	Max.	UNIT
Write Cycle Time	t _{wc}	t _{cw}	10	—	ms
Write Pulse Width	t _{wp}	t _w (CE)	210	—	ns
Address Setup Time	t _{as}	t _{su} (A)	10	—	
Data Setup Time for $\overline{\text{CE}}$	t _{ds}	t _{su} (D-CEH)	100	—	
Write Enable Setup Time	t _{wes}	t _{su} (WE)	0	—	
Output Enable Setup Time	t _{oes}	t _{su} (OE-CE)	45	—	
Address Hold Time	t _{ah}		260	—	
Write Hold Time	t _{wh}		0	—	
Output Enable Hold Time	t _{oeh}		70	—	
$\overline{\text{CE}}$ HIGH Hold Time	t _{ceh}		9.9	—	
Data Hold Time	t _{dh}	t _h (D)	80	—	ns

15. Specification Changes

Specifications may be changed upon discussion and agreement between both parties.

16. Othes Precautions

- Permanent damage occurs if the memory card is stressed beyond Absolute Maximum Ratings. Operation beyond the Recommended Operating Conditions is not recommended and extended exposure beyond the Recommended Operating Conditions may affect device reliability.
- Writing to the memory card can be prevented by switching on the write protect switch on the end of the memory card.
- Avoid allowing the memory card connectors to come in contact with metals and avoid touching the connectors, as the internal circuits can be damaged by static electricity.
- Avoid storing in direct sunlight, high temperatures (do not place near heaters or radiators), high humidity and dusty areas.
- Avoid subjecting the memory card to strong physical abuse. Dropping, bending, smashing or throwing the card can result in loss of function.
- When the memory card is not being used, return it to its protective case.
- Do not allow the memory card to come in contact with fire.

SHARP

(A) ENLARGEMENT OF THE
WRITE-PROTECT SWITCH

17. External Diagrams

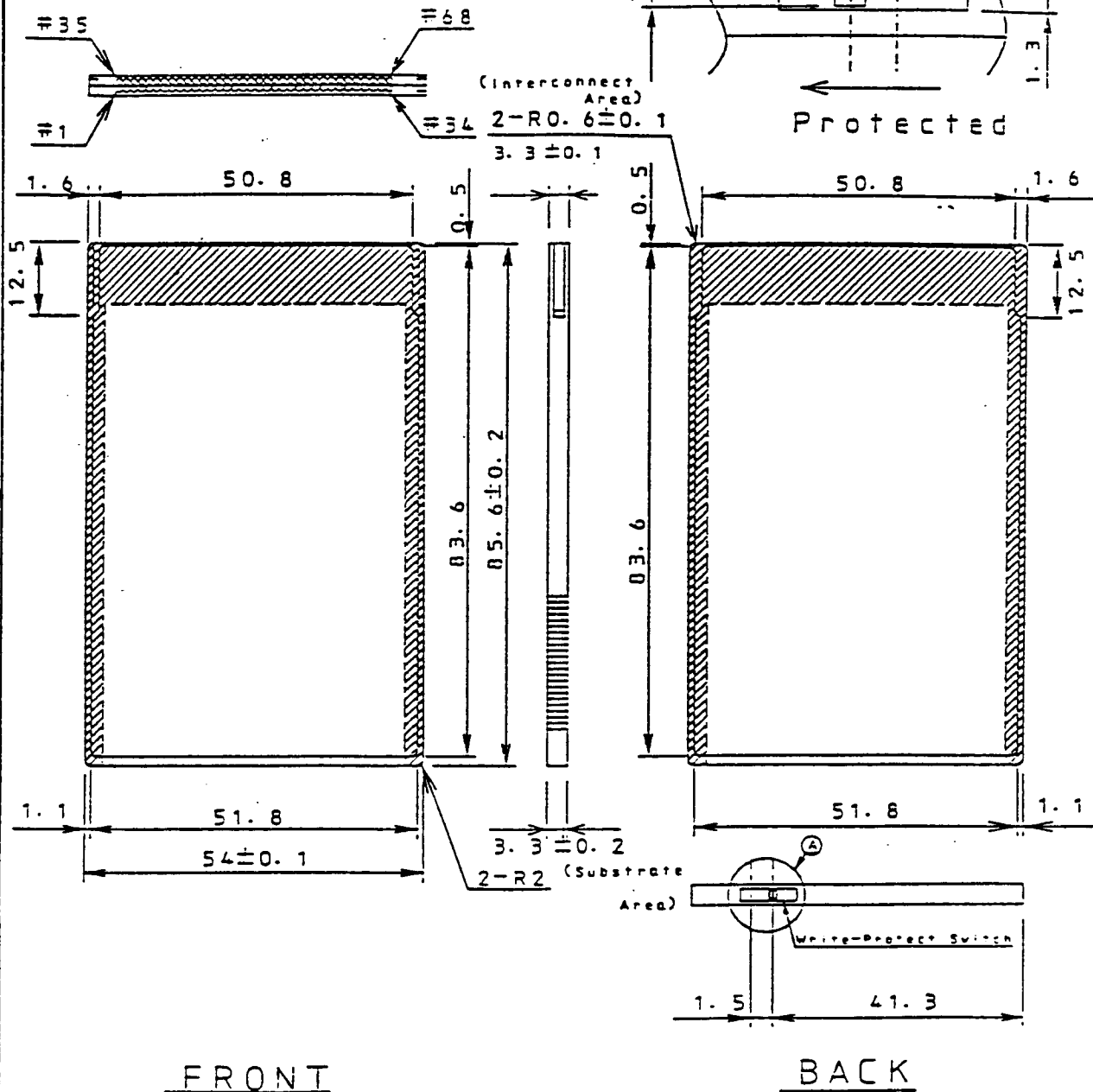

FRONT

BACK

APPLICABLE		SCALE	UNIT	(A)	
MODEL		1 / 1	mm	(A)	
THICKNESS		MATERIAL	FIN. SM	CH. DATE	REVISE
					MEMORY CARD
DATE	1994.11.10				EXTERNAL DIAGRAM
DESIGN/ DRAW	TRACE/ CHECK	Memory Card Business Project Team			PCMCIA Rel. 2.0 TYPE:
		TENRI IC GROUP			
		SHARP CORPORATION			DRAWING NO. 1MCD01-A102

18. PACKING SPECIFICATION

Connector Side

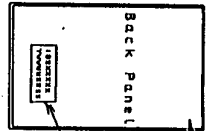

Note 2

Parts List	Parts Name
A	Flexible Plastic Case
B	Inner Carton (25 pieces contained)
C	Outer Carton (100 pieces contained)
D	Outer Case (400 pieces contained)

Connector Side

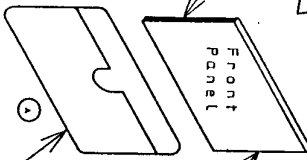

Flexible Plastic Case

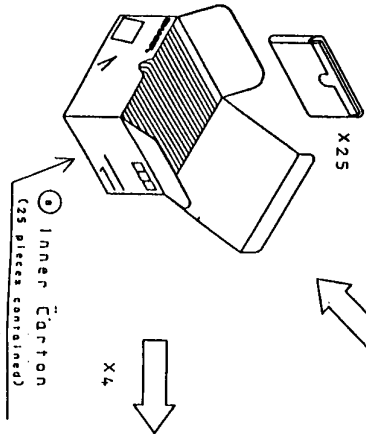

Inner Carton (25 pieces contained) X4

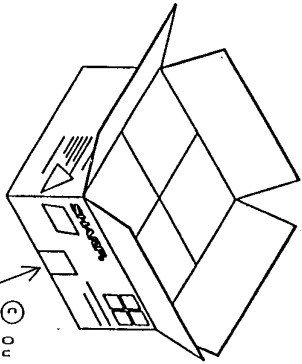

Outer Carton (100 pieces contained) X4

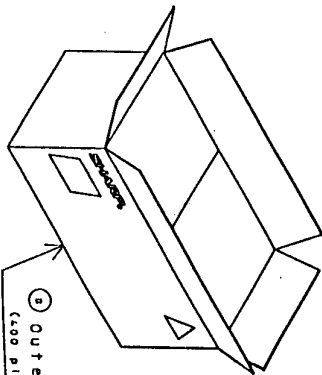

Outer Case (400 pieces contained) X4

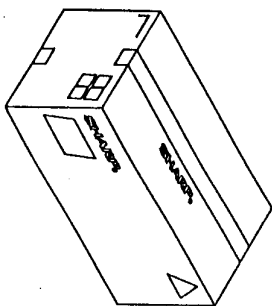

Packing Specification

- Label the model No. and Manufacturing No. on the back panel of the card.
- Each Memory card is contained in the flexible plastic case. (The Flexible side of the case comes to the place where the card panel and the connector side is placed against to this panel.) The connector is not touched by finger, as shown in the figure.)
- The inner carton contains 25 pieces of the card with the case. (Note 1.)
- The product name, lot no. (product no.), quantity and the date are either written directly on the inner carton or printed on the label which is then attached on inner carton.
- The outer carton contains 4 inner cartons. (Note 2.)
- The product name, lot no. (product no.), quantity and the date are either written directly on the outer carton or printed on the label which is then attached on the outer carton.
- The outer carton is then put in the outer case, which contains 4 outer cartons. (Note 3.)
- The product name, lot no. (product no.), quantity and the date are either written directly on the case or printed on the label which is then attached on the case.

ID24xxxx

- Note 1: The least packing unit is 25 pieces, which is the number contained in the inner carton.
- The space inside the outer carton is filled card board.
 - The other size of outer case may be used if there is not enough quantity to fill the normal outer case which can contain 4 outer cartons.
 - Size of label and dimensions are following: (unit:mm)

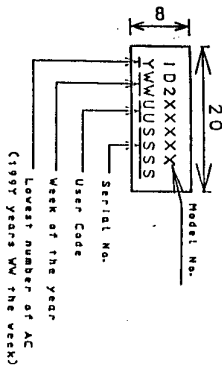

APPLICABLE	SCALE	UNIT	Δ
MODEL	ID2XXXX	MM	Δ
THICKNESS	DIFFERENCE	MATERIAL	FINISH
DATE	1988.10.10	NAME	ID2XXXX
SHARP CORPORATION		REVISION	CHARGE
SHARP CORPORATION		Packing Specification	
DRAWING NO.		IC025-0300	

SHARP

19. EXTERNAL APPEARANCES

CONNECTOR SIDE

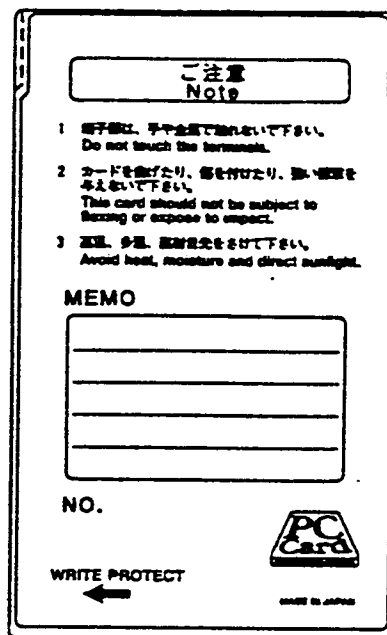
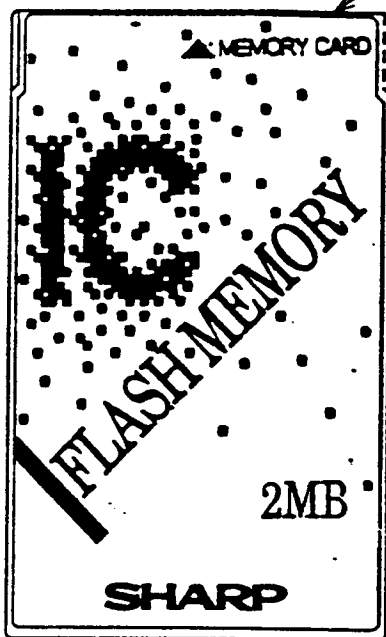

Labeling position

FRONT PANEL

Part No	PA-R1-FF-045
Back Ground	DIC No. 290 Ver. 1
IC Text	DIC No. 906 Ver. 5
Other Characters	
MEMORY CARD FLASH MEMORY 2MB SHARP	DIC No. 651
Design	Refer to above figure

BACK PANEL

Part No	PA-R1-FR-001
Back Ground	DIC No. 290 Ver. 1
Text	Colorless
Characters On label	Black
Design	Refer to above figure

Frame Part No: FR-R1-10
Color : Black

Label Size and Denotations

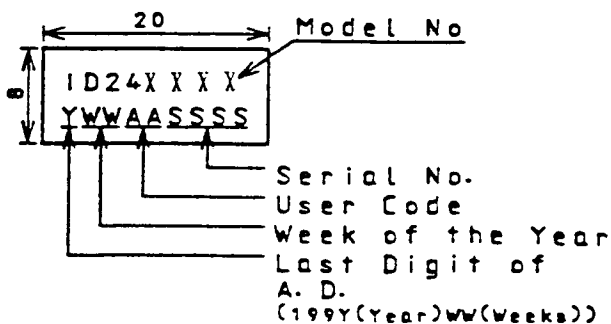

APPLICABLE MODEL		SCALE	UNIT			
	ID24XXX	1/1	mm			
THICKNESS	DEPTH	MATERIAL	FINISH	CH. DATE	REVISE	CHARGE
DATE	1998. 7. 6	NAME			ID24XXX EXTERNAL APPEARANCES	
		SYSTEM MODULE BUSINESS P. T				
		INTEGRATED CIRCUITS GROUP				
		SHARP CORPORATION			DRAWING NO.	IMC203-P100

Series 2, 2 MB, PCMCIA, Flash Card, ID240D01, Type 1